

AS-104

ROUND BAR WITH EYEBOLTS,
LOOPED MESH

info@amronarchitectural.co.uk | +44 (0) 1795 228 583 |
Amron Architectural Limited 9-10 The Foundry Business
Park, Seager Road, Faversham, Kent, ME13 7FD

Shapes

— Straight

Compatible Meshes

CM-200
CM-210
CM-210-1

Applications

Facades
Wall Covering
Fencing & Enclosures
Partitioning & Room Dividers

Materials

Stainless Steel

Top Fixings

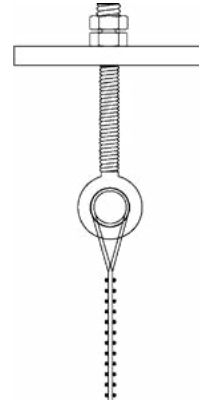

Intermediate Fixings

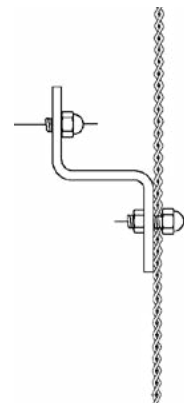

Bottom Fixings

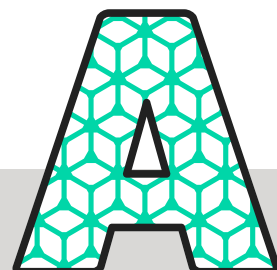
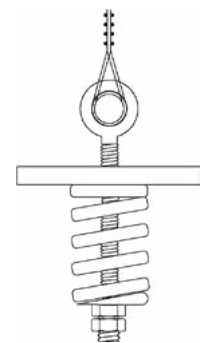
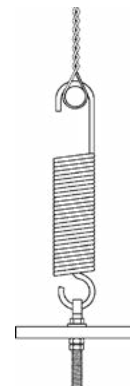
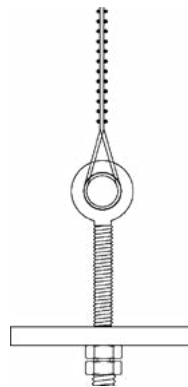

AS-104

ROUND BAR WITH EYEBOLTS,
LOOPED MESH

info@amronarchitectural.co.uk | +44 (0) 1795 228 583 |
Amron Architectural Limited 9-10 The Foundry Business
Park, Seager Road, Faversham, Kent, ME13 7FD

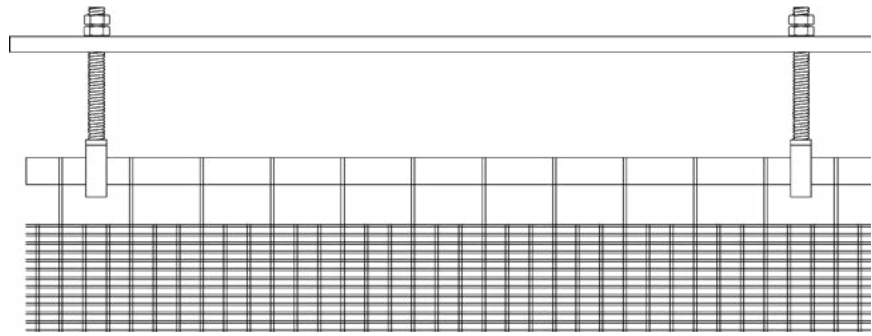

Top Fixings

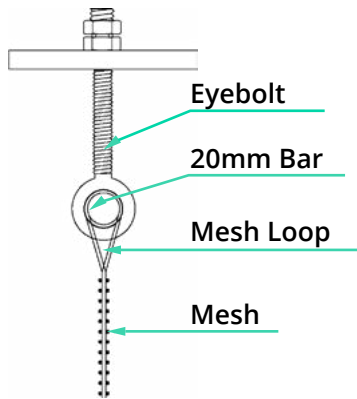

Intermediate Fixings

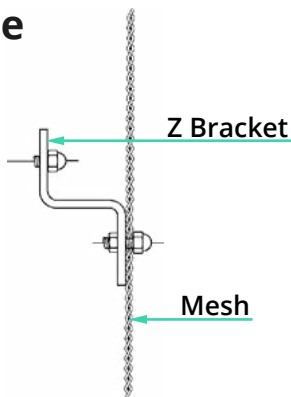

Bottom Fixings

