

AW200

TECH GUIDE

SCORE FOLDED SYSTEM

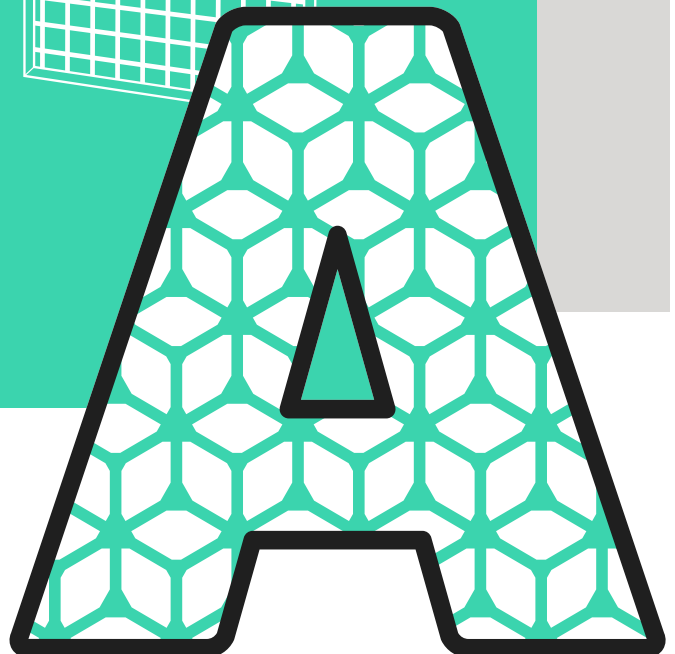
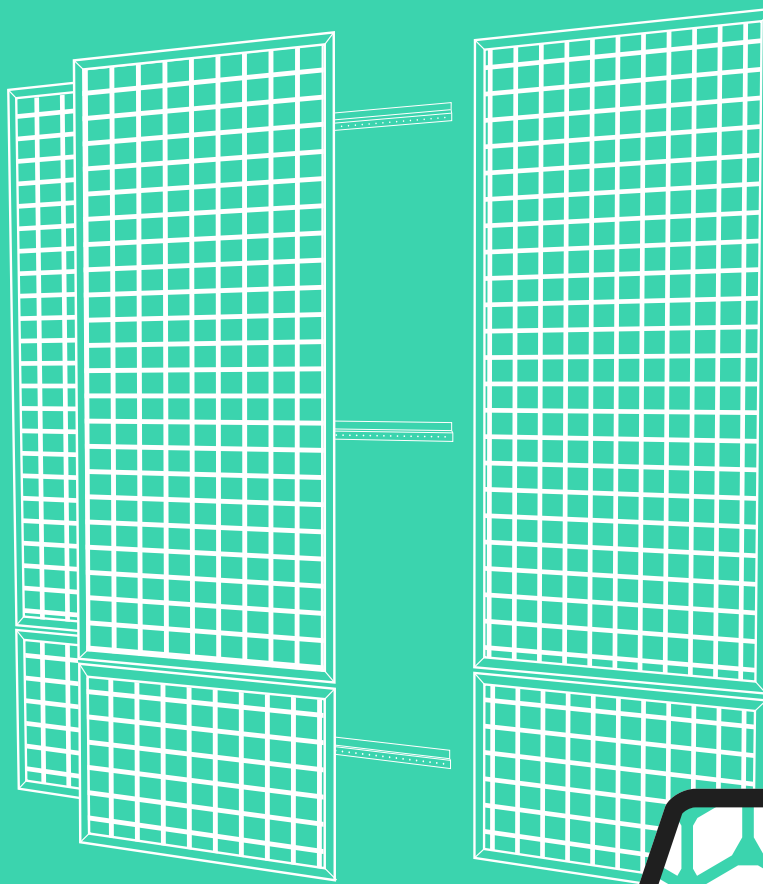

info@amronarchitectural.co.uk

01795 228 583

9-10 The Foundry Business Park,
Seager Road, Faversham,
Kent, ME13 7FD

System Overview



Hidden Fixings

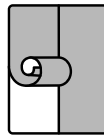

Internal Walls



Variable

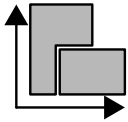

**MAX. 1000 x
3000 mm**

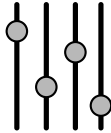

**Customisable
Options**



**Integrated
services**



**Dependent
on Finish**

Compatible Meshes

Our AW200 series is a range of made to order key slot wall panel systems. This series uses a varied range of our quality materials such as:

Expanded Mesh

Woven Mesh

Perforated Sheet

Fret Cut Panels

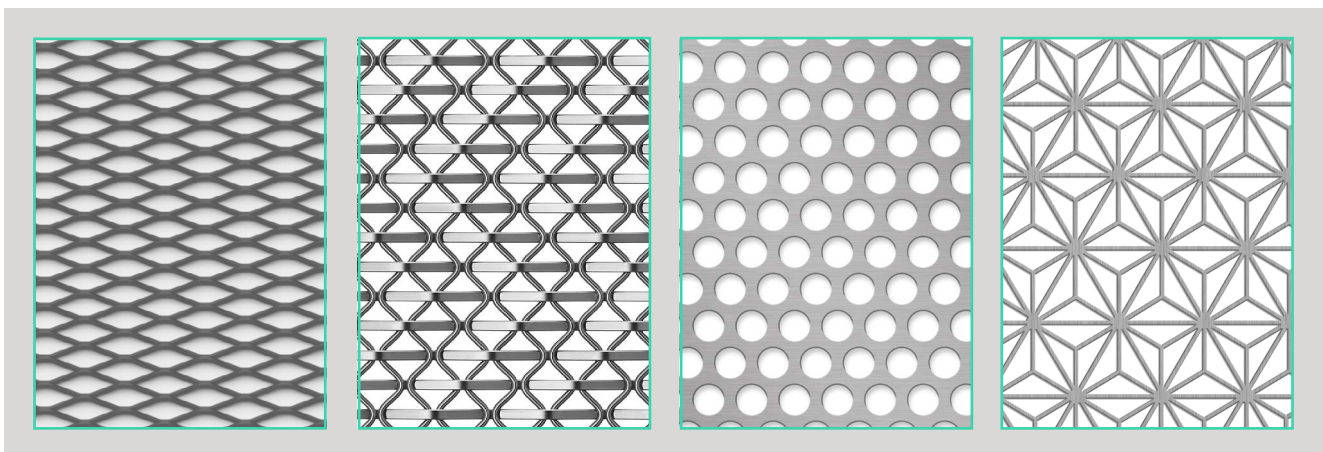

Finishes Range

We offer any RAL colours or bespoke powder coat finishes, as well as, decorative plated finishes. Exterior finishes are also available.



Powder Coat



PVD



**Decorative
Plated Finish**



Anodised



To find out more about the colours in our range, please contact our team.

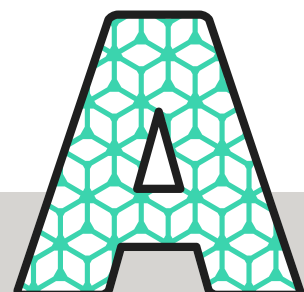

Technical Details

Key

- 1** Mesh Panel
- 2** Backing Panel
- 3** Countersunk Screw
- 4** Scored Frame
- 5** Z-Hook Wall Bracket

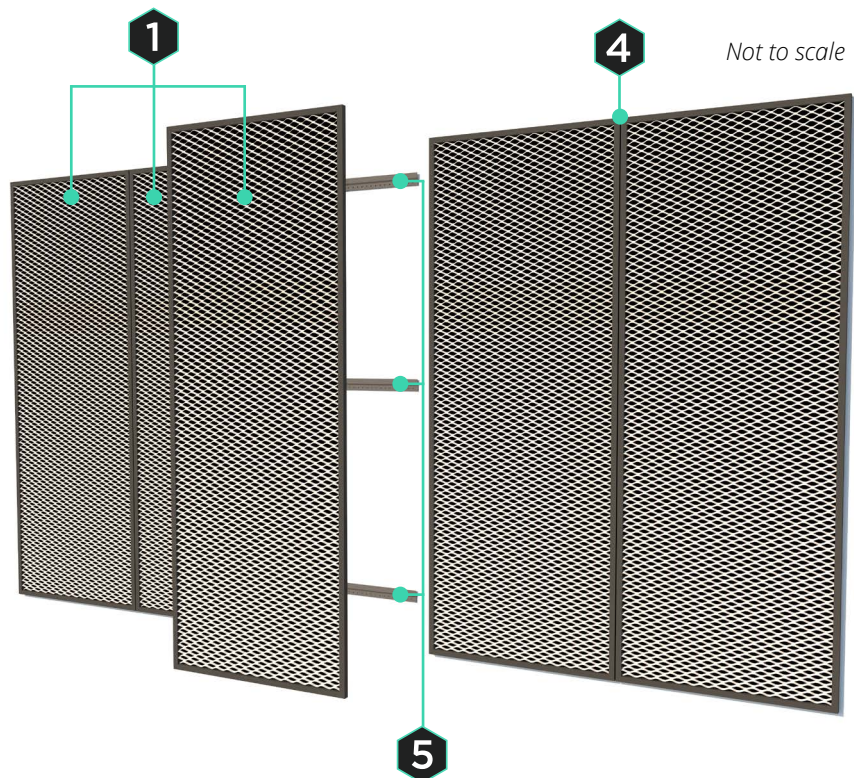

Side View Detail

Not to scale

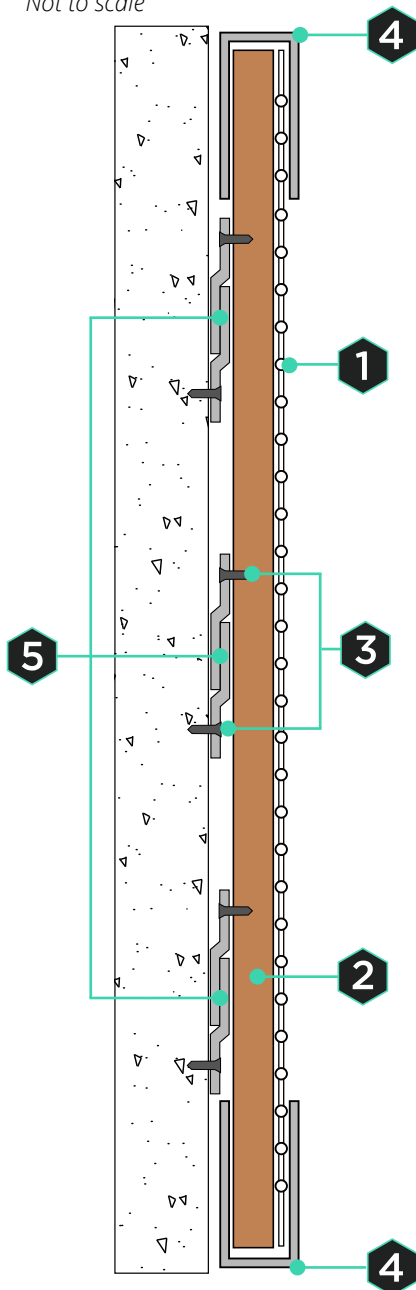

Plan View:
Panel configuration detail

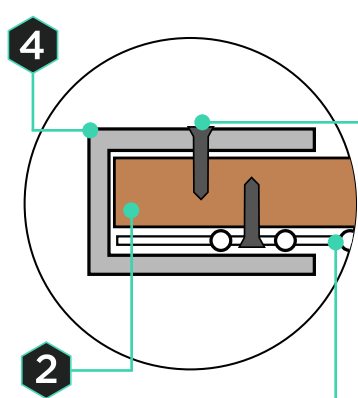

Side View:
Mounting detail

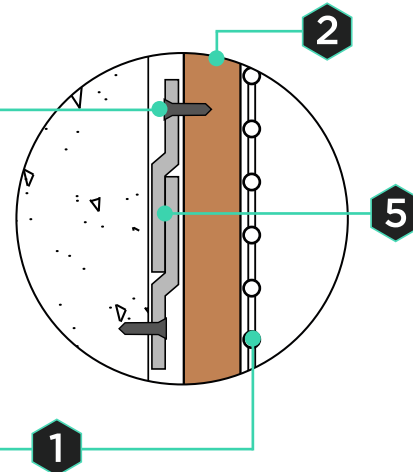

! Contact our Technical team on info@amronarchitectural.co.uk if you need more details on our systems.

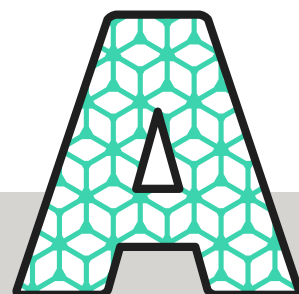

Configurations

Single Run

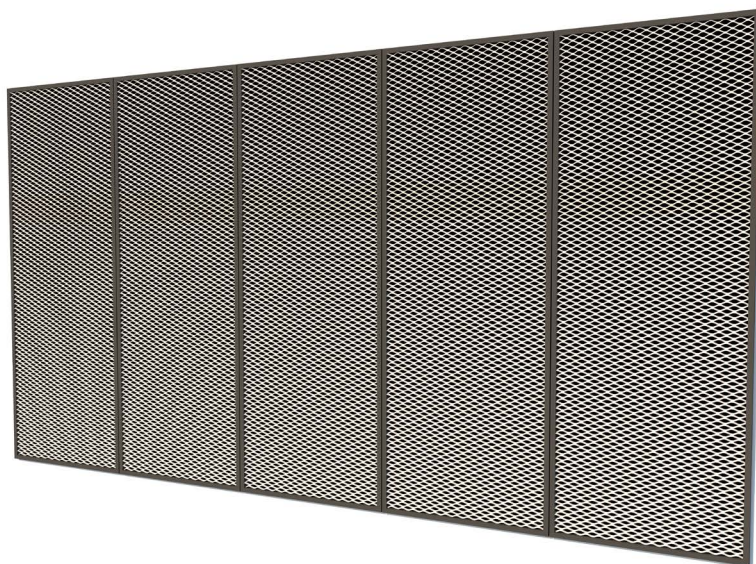

Varying Sizes

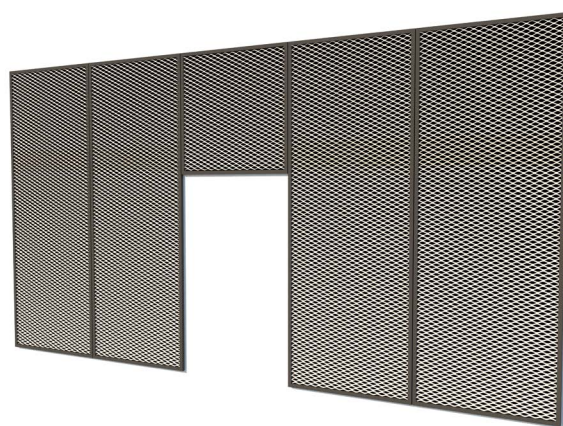
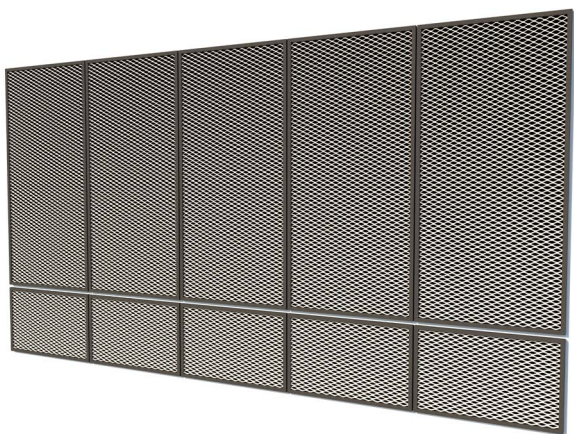

Contact our Technical team on info@amronarchitectural.co.uk if you need more details on our systems.

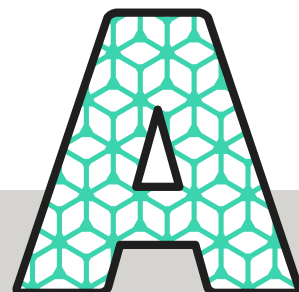

AW200 Case Studies



Juwelier Hunke - *Ippolito Fleitz Group*

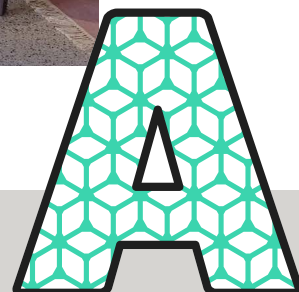

AW200 Case Studies



Juwelier Hunke - Ippolito Fleitz Group

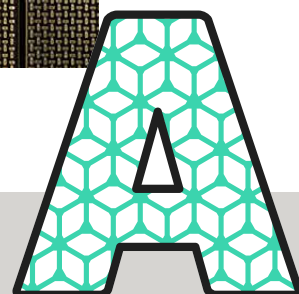

AW200 Case Studies



Montgomery Building - *G-S Company*



AW200 Case Studies

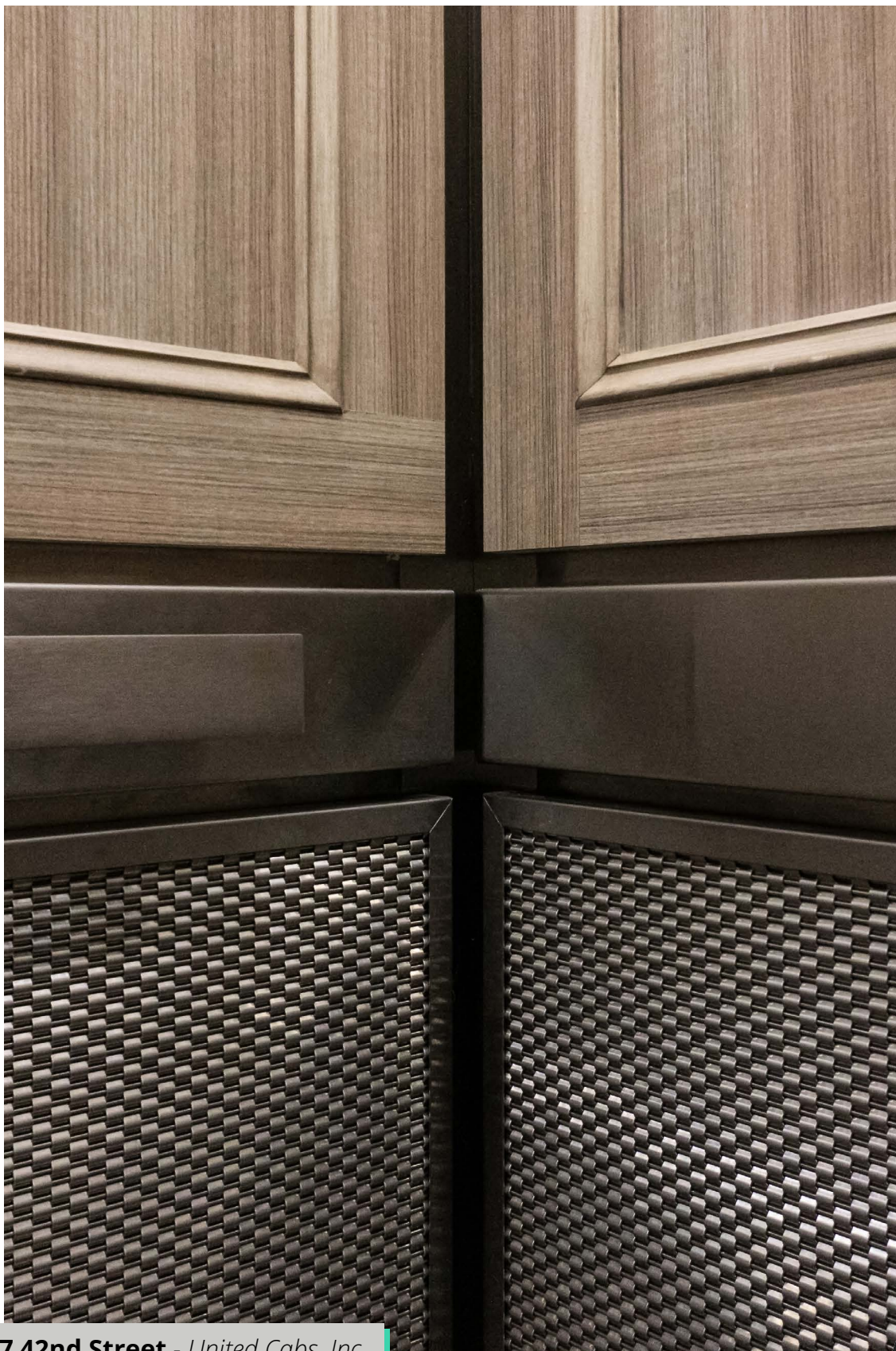

41-07 42nd Street - *United Cabs, Inc.*

